

29.5.3 Physics Paper 3 (232/3)

Name Index Number/.....

232/3
PHYSICS
Paper 3
(PRACTICAL)
Oct./Nov. 2008
 2 ½ hours

Candidate's Signature

Date

THE KENYA NATIONAL EXAMINATIONS COUNCIL
Kenya Certificate of Secondary Education
PHYSICS
Paper 3
(PRACTICAL)
 2 ½ hours

Instructions to candidates

Write your name and index number in the spaces provided above.
Sign and write the date of examination in the spaces provided above.
Answer ALL the questions in the spaces provided in the question paper.
You are supposed to spend the first 15 minutes of the 2½ hours allowed for this paper reading the whole paper carefully before commencing your work.
Marks are given for a clear record of the observations actually made, their suitability, accuracy, and the use made of them.
Candidates are advised to record their observations as soon as they are made.
Non-programmable silent electronic calculators and KNEC mathematical tables may be used except where stated otherwise.

For Examiner's use only

Question 1

	c	d	ei	eii	g	h
Maximum Score	5	5	3	2	3	2
Candidate's Score						

Total

Question 2

	a	e	fi	fii	fiii	g(i)	g(ii)	hi	hii
Maximum Score	1	6	5	1	2	1	1	1	2
Candidate's Score									

Total

Grand Total

This paper consists of 11 printed pages.

Candidates should check the question paper to ascertain that all the pages are printed as indicated and no questions are missing.

Question 1

*This question consists of two parts A and B.
Attempt both parts.*

PART A

You are provided with the following:

- copper wire
- a retort stand, boss and clamp
- an optical pin mounted on a cork
- a stop watch
- wire cutters (to be shared)
- a metre rule or half metre rule.

Proceed as follows:

- (a) Clamp the cork so that the optical pin is horizontal. Hang the copper wire from the pin by the loop as shown in figure 1. Ensure the wire is straight and the length X between the lower tip and the optical pin is 32 cm. If the length exceeds 32 cm reduce by cutting at the lower tip using the wire cutters provided.

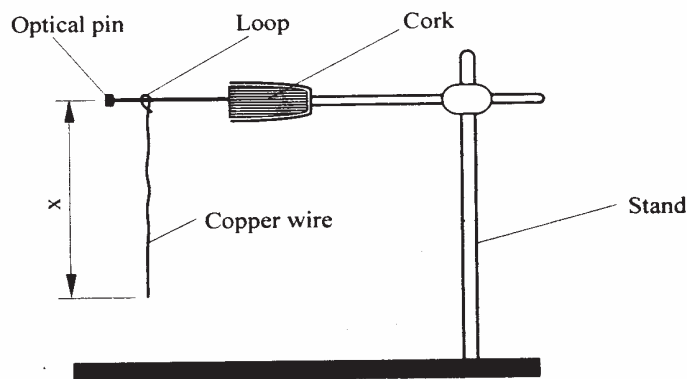

Figure 1

- (b) Displace the lower tip of the wire slightly in a plane perpendicular to the optical pin and then release it. Measure the time t for 20 oscillations of the wire and record the value in table 1.
- (c) Repeat the procedure in (b) above for other values of X shown in the table. (*Note that each length X is obtained by cutting off an appropriate length from the lower tip of the wire. For example to get $X = 28$ cm cut off 4 cm from the lower end*). Complete the table.

Table 1

Length X (cm)	32	28	24	20	16	12
time t for 20 oscillations (s)						
Period $T = t/20$ (s)						
T^2 (s ²)						

5 marks

(d) Plot a graph of T^2 (y-axis) against x .

(5 marks)

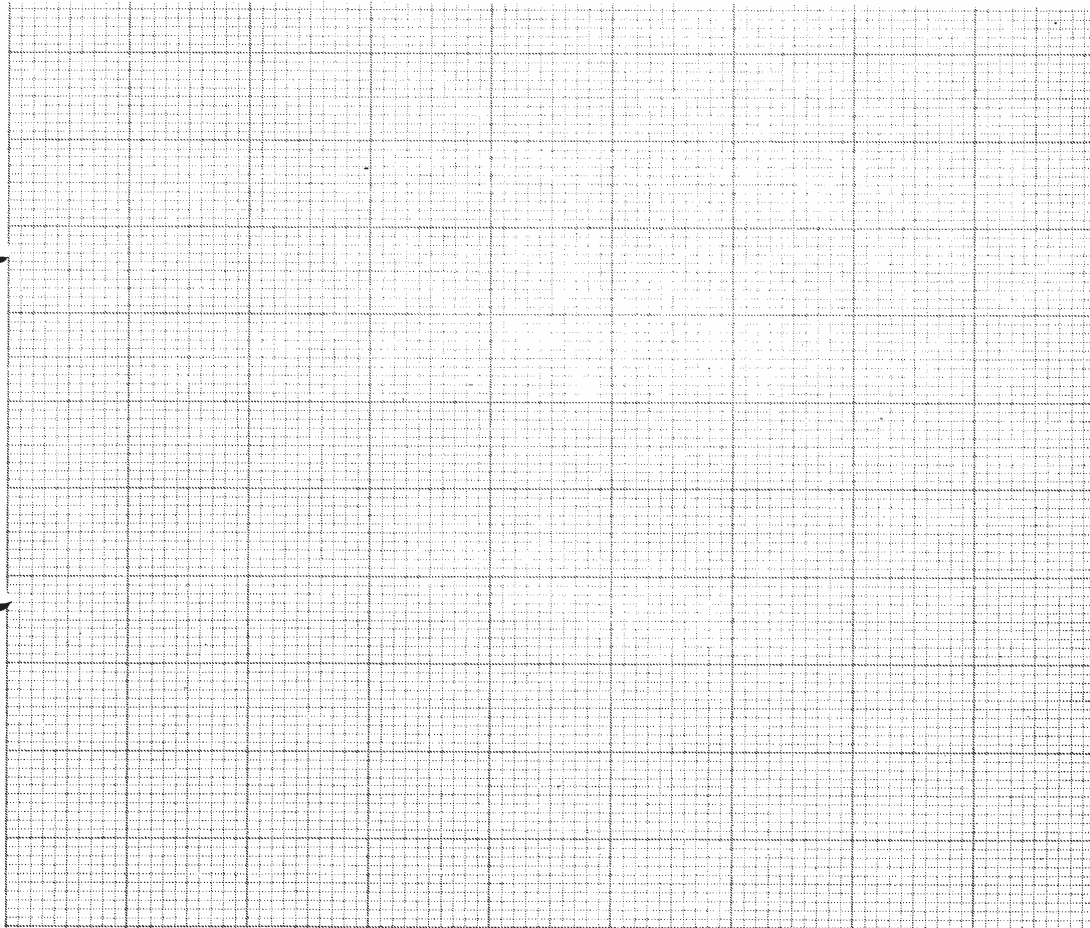

(e) (i) Determine the slope, S , of the graph .

(3 marks)

(ii) Obtain the value of k in the equation $S = \frac{8\pi}{3k}$

(2 marks)

PART B

You are provided with the following:

- a cylindrical container
- some water
- a stop watch
- a metre rule or half-metre rule
- a boiling tube
- some sand
- a rubber band

Proceed as follows:

- (f) Tie the rubber band round the boiling tube so that it is at a distance $L = 12\text{ cm}$ from the bottom of the tube (see fig 2a). Pour water into the cylindrical container until the level is about 2.0 cm from the top of the beaker. Float the boiling tube in the water in the container. Add sand gradually into the boiling tube until the tube sinks to the 12 cm mark. See figure 2(b).

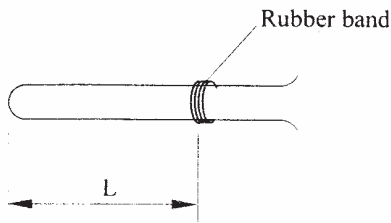

Figure 2(a)

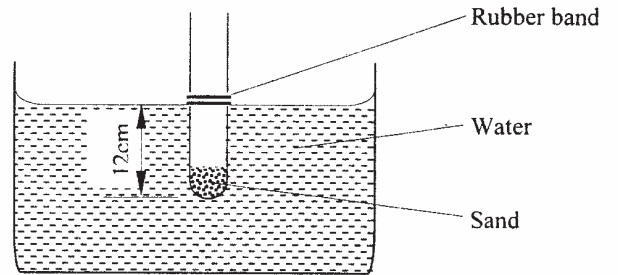

Figure 2(b)

- (g) Depress the boiling tube slightly and release so that it oscillates vertically without touching the sides of the container. Measure and record in table 2 the time t_1 , for five oscillations of the boiling tube. Repeat the procedure two more times to obtain t_2 , and t_3 and record the values in table 2. Complete the table.

Table 2

t_1 (s)	t_2 (s)	t_3 (s)	Average t (s) $t = \left(\frac{t_1 + t_2 + t_3}{3} \right)$	$T = \frac{t}{5}$ (s)

(3 marks)

- (h) Evaluate $P = \frac{40L}{T^2}$ given that L is the length of the tube upto the rubber band in (f) and T is the value obtained in (g) above. (2 marks)

Question 2

This question consists of two parts: **A** and **B**.
Attempt both parts.

PART A

You are provided with the following:

- a triangular glass prism
- a piece of soft board
- four (4) optical pins
- a sheet of plain paper.

Proceed as follows:

- (a) Place the plain sheet of paper on the soft board. Trace the triangular outline of the prism on the sheet of paper. Remove the prism and use a ruler to extend the three sides of the outline. See figure 3(a).

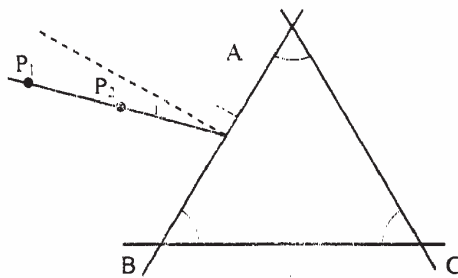

Figure 3(a)

Use a protractor to measure the refracting angle R of the prism.

- (b) On the side AB of the triangular outline, draw a normal at a point half-way between A and B . *This normal will be used for the rest of this experiment.*
- (c) Draw a line at an angle $i=30^\circ$ to the normal. Stick two pins P_1 and P_2 vertically on this line. See figure 3(a). (5 marks)
- (d) Place the prism accurately on the outline. By viewing through the prism from side AC stick two other pins P_3 and P_4 vertically such that they are in line with the images of pins P_1 and P_2 . Remove the prism and the pins. Draw a line joining marks made by P_3 and P_4 . Extend this line to meet AC . (See figure 3(b)). Measure and record in table 3 the value of angle θ .

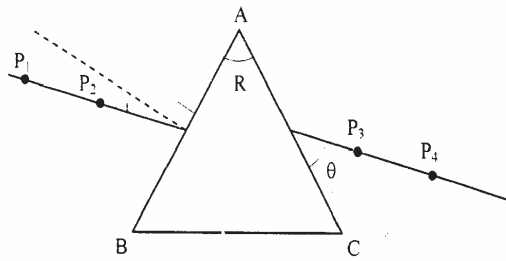

Figure 3(b)

- (e) Repeat the procedures in (c) and (d) above for other values of i shown in table 3. Complete the table.

N.B. *The sheet of paper with the drawing must be handed in with this question paper. Ensure you write your name and index number on the sheet of paper.*

Table 3

Angle of incidence i (deg)	30	35	40	45	50	55	60
Angle θ (deg)							
Angle of emergence, $E=90-\theta$ (deg)							

(6 marks)

- (f) (i) On the grid provided plot the graph of the angle of emergence E (y-axis) against the angle of incidence i . (5 marks)

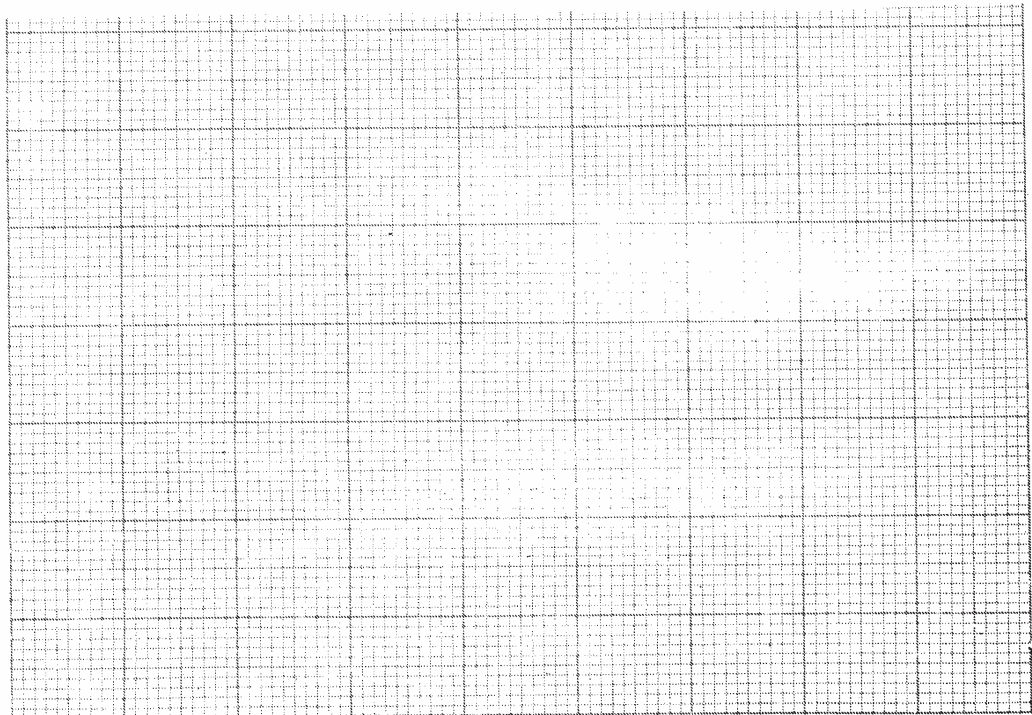

(ii) Use the graph to find i_0 the angle of incidence at which $i = E$ (1 mark)

(iii) Evaluate

(I) $y = 2i_0 - R$ (1 mark)

(II) $b = 2 \sin i_0$ (1 mark)

PART B

You are provided with the following:

- a lens and a lens holder
- a screen with cross-wires
- a candle
- a metre rule

Proceed as follows:

- (g) Arrange the lighted candle, the lens and the screen as shown in figure 4. Adjust the position of the screen until a sharp inverted image of the candle is formed on the screen.

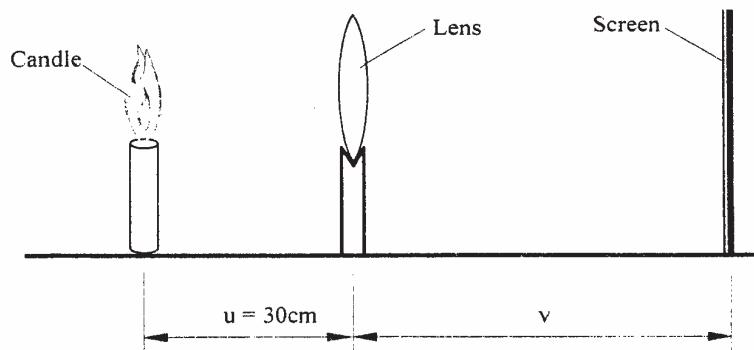

Figure 4

- (i) Measure the image distance v ,
- (ii) Determine the focal length of the lens using the formula.

$$f = \frac{uv}{u+v} \quad (1 \text{ mark})$$

- (h) Now arrange the lighted candle, the screen with cross wires and the lens as shown in figure 5. Ensure that the centre of the lens, the cross-wires, and the candle flame lie on the same horizontal line. The candle flame should be placed close to the cross-wires for better illumination.

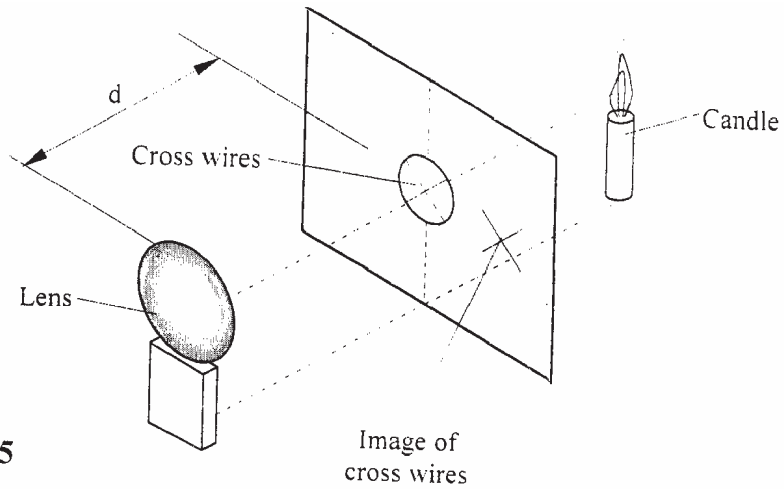

Figure 5

- (i) Adjust the position of the lens until a sharp image of the cross-wires is formed on the screen next to the crosswires. (*Hint: You may have to rotate the lens slightly about a vertical axis so that the image of the cross-wires falls on the screen next to the cross-wires and not on the cross-wires*).

Measure the distance d , between the lens and the screen.

$d =$ cm (1 mark)

- (ii) Evaluate:

I. $L = \frac{df}{f-d}$ (1 mark)

II. $X = \frac{L}{2f} + 1$ (1 mark)